









# Produktinformation

mawa®

oskar

## TISCHLEUCHTE **os1-dim**

oskar ist die Allzweckleuchte für stimmungsvolles Licht – ideal um auf Sideboard, Klavier oder Regal Räume zu akzentuieren. Darüber hinaus erzeugen Spiegelungen in den Chrom-, Kupfer- und Messingvarianten einen brillanten Effekt. Der zylindrische Leuchtenkorpus ist aus einem Teil geformt. Bei dem Herstellungsverfahren – Metalldrücken genannt – handelt es sich um traditionelle Handarbeit. So machen marginale Unterschiede in den Oberflächen aus jeder Leuchte ein Unikat. Diese Version von oskar hat einen Dimmschalter.

-  kupfer mit grauem Textilkabel
-  messing mit grauem Textilkabel
-  chrom mit grauem Textilkabel
-  schwarz matt (RAL 9005) mit grauem Textilkabel
-  schwarz matt (RAL 9005) mit orangem Textilkabel
-  zementgrau Feinstruktur (RAL 7033) mit grauem Textilkabel
-  bordeauxviolett Feinstruktur (RAL 4004) mit grauem Textilkabel
-  ozeanblau Feinstruktur (RAL 5020) mit grauem Textilkabel
-  industrial mit grauem Textilkabel



Beispielhafte Darstellung:  
Gehäuse kupfer mit Leuchtmittel von Sigor  
Gehäuse schwarz (RAL 9005) mit Leuchtmittel von Paulmann  
Empfohlene Leuchtmittel: mawa-design.de

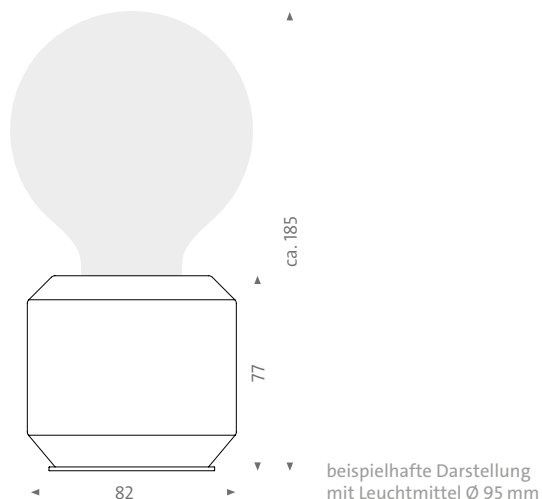

### os1-dim

Design: Marco Schölzel, Martin Wallroth

Gehäuse: kupfer, messing, chrom, industrial

pulverbeschichtet: schwarz matt (RAL 9005),

zementgrau, bordeauxviolett, ozeanblau

**Fassung:** E27, max. 60 W

Textilkabel mit Dimmschalter:

grau bei kupfer, messing, chrom, industrial,

zementgrau, bordeauxviolett, ozeanblau

grau oder orange bei schwarz matt, Länge 1,80 m

Schutzklasse I, Schutzgrad IP20

Leuchtmittel: exklusive Leuchtmittel

Gewicht (exklusive Leuchtmittel): 482 g









## Product Information

mawa®

oskar

### TABLE LAMP **os1-dim**

oskar is the all-around lamp for atmospheric light – set upon a sideboard, piano, or shelving – the perfect way to accent rooms. Additionally, reflections in the chrome, copper, and brass versions create brilliant effects. The cylindrical body of the lamp is formed from a single piece of metal. This particular production process – known as metal spinning – is a traditional method of craftsmanship. Therefore, marginal differences in object surfaces resulting from the handcrafted process make each light one-of-a-kind. This version of oskar has a dimmer switch.

-  copper with grey textile cable
-  brass with grey textile cable
-  chrome with grey textile cable
-  black matt (RAL 9005) with grey textile cable
-  black matt (RAL 9005) with orange textile cable
-  cement grey fine structure (RAL 7033) with grey textile cable
-  bordeaux violet fine structure (RAL 4004) with grey textile cable
-  ocean blue fine structure (RAL 5020) with grey textile cable
-  industrial with grey textile cable



Exemplary representation:  
Housing copper with light bulb by Sigor  
Housing black matt (RAL 9005) with light bulb by Paulmann  
Recommended illuminants: [mawa-design.de/en/](http://mawa-design.de/en/)

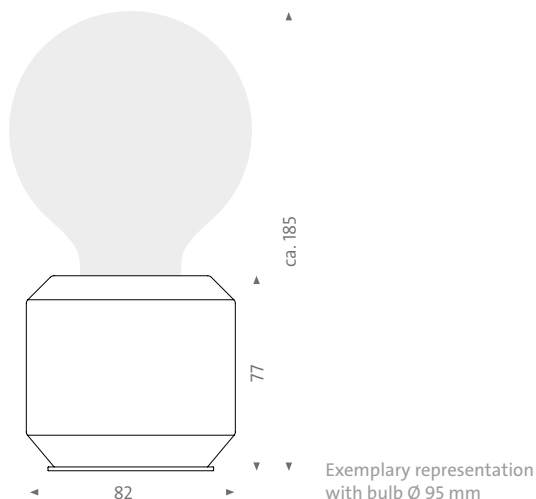

#### **os1-dim**

Design: Marco Schölzel, Martin Wallroth

Housing: copper, brass, chrome, industrial

powder coated: black matt (RAL 9005),

cement grey, bordeaux violet, ocean blue

**Socket:** E27, max. 60 W

textile cable with dimmer switch:

grey at copper, brass and chrome, industrial

cement grey, bordeaux violet, ocean blue

grey or orange at black matt, length 1,80 m

Protection class I, Degree of protection IP20

Illuminant: bulb not included

Weight (exclusive illuminant): 482 g